

THE PYRAMID HILLS: *VISOČICA* AND *PLJEŠEVICA HRAŠĆE*

OBSERVATIONS, AND ANALYSES

30 August to 12 September 2007

Nabil Swelim

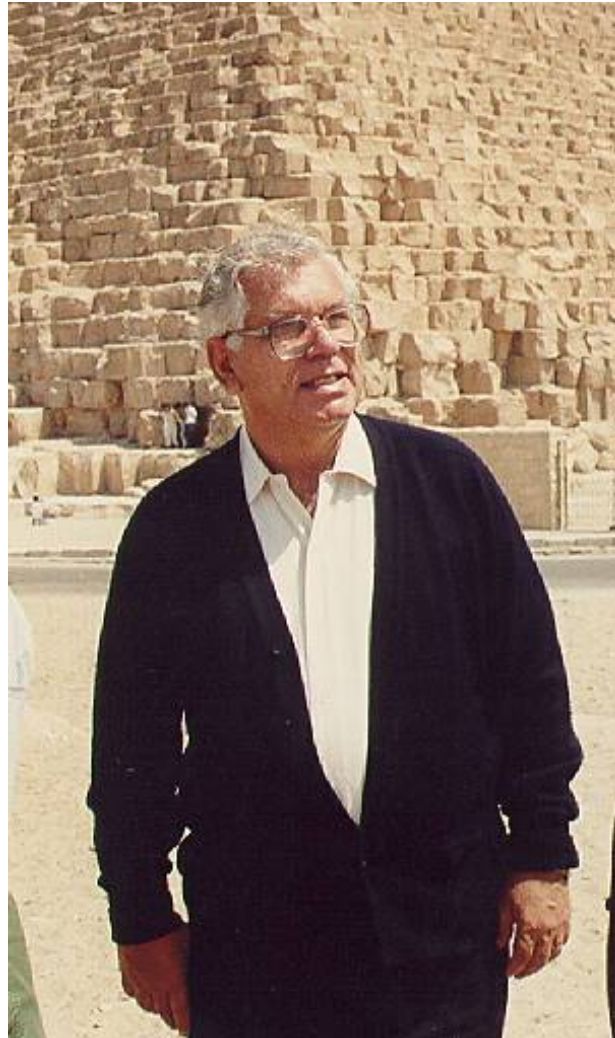

At the SW corner of the great pyramid

Rear Admiral (retired), Ba, Ma, M.sc., PhD (*summa cum laude*), Habilitation, currently D.sc. Candidate.

Egyptologist, Pyramid research, Art and Architecture

Author and Photographer

THE PYRAMID HILLS: *VISOČICA* AND *PLJEŠEVICA HRAŠĆE*

OBSERVATIONS, AND ANALYSES

30 August to 12 September 2007¹

Nabil Swelim

During our stay in Bosnia, there were meetings with Authorities of the highest level, University Rectors, Scientists, Scholars, Ambassadors and I delivered 2 lectures. Salwa, my wife, and I enjoyed the Bosnian hospitality and warmth of its people. I am grateful to The Archaeological Park Foundation: Bosnian Pyramid of the Sun for inviting me to see the sites and for giving me access to all records I requested. I believe the data acquired so far is only the tip of an iceberg, which will become a milestone on the track of pyramid research. The sites visited were:

- THE VALLEY OF THE PYRAMIDS (AT VISOKO).
- THE MOUND TOPRAKALIA (AT VRATNICA).
- TUNNELS KTK AND RAVNE (AT VISOKO).
- BOSNIAN SPHERES (AT ZAVIDOVIĆI).

In this report only two features of the Valley are being observed and analysed. During a short visit with so much to do I was unable to achieve all that I would have liked to. As a matter of fact some learning was done here in Cairo after our return from Bosnia. I acquired additional knowledge from hundreds of photographs Salwa and I took during our visit and from others that I asked the Foundation to supply. Much information came from Foundation members, documents and from geologists, visitors, journalists, interviews, opponents and blogs on the internet.²

There are many branches of science involved in this endeavour. The following are only a few:

- GEOLOGY.
- PYRAMID STUDIES.
- CIVIL ENGINEERING.
- GEOPHYSICS.
- MINING.
- SATELLITE IMAGES.
- ARTIFACTS.
- PETRO GLYPHS.

¹ My thanks go to a long list of friends in Sarajevo, to Salwa my wife for her never failing help, to Pamela Reynolds of Chicago, Sharon Wothke of Huston for reading the manuscript and making important improvements and to Merima Bojic of Los Angeles for her continued corporation.

² A few ladies and gentlemen, who have criticized or shown their disapproval of the Foundation, contacted me from Bosnia, Europe and the United States. They have tried to convince me, in forms of advice or their judgments to: abandon pyramid studies in Bosnia, reject the Foundation's project and discredit its director. I could not see any scientific reasoning in their arguments. I hope in the future they will argue the scientific sides only and refrain from publishing untruths.

This is a wide scope of scientific subjects and no one can claim that their knowledge covers all. That is why the Foundation bears the heavy task of coordinating the research of so many specialists. Nevertheless, arguments in favour or in disfavour have no effect on the fact that the pyramid concepts and properties are there for everyone to see. News of the discovery of other pyramid hills is adding to the scientific importance of this new branch of pyramid research.

Now this preliminary report is coming to an end. The others subjects are pending and are mentioned at the end of this article.

MAP OF BOSNIA AND HERZEGOVINA



THREE SITES WITH PYRAMID HILLS AND ONE WITH SPHERES

FORWARD

In Bosnia a historical blackout predates and almost covers Illyrian and Greco-Roman times. In the ancient world, the geographical location of that country is out of the way of the main routes of trade. Nevertheless these imposing pyramid hills at Visoko could never be ignored; I don't understand how the history of the hills and their cultural background evaporated, but I am sure that they can eventually be retrieved. On the other hand, Egypt is the cross roads of trade; by constantly seeing the pyramids of Egypt they were always remembered.

The solid base on which the Archaeological Park Foundation survives is the undeniable appearance of the hills at Visoko which are geometrically known as pyramids.

The Foundation has successfully established itself nationally and internationally. Now it has arrived at a delicate phase of maintaining this preliminary success; this will be achieved by: increasing its field work, its academic research and constantly updating the present data. I would like the Foundation to invite scholars to attend workshops on geological and petro glyphic matters at Visočica and Pljesevica Hrašće.

In this report I approach the subject as being an important branch of pyramid research. I am an Egyptologist who has studied, excavated and discovered pyramids in Egypt, and visited others abroad. I consider that these pyramid hills stand out among other pyramid studies as being unique.

This report covers all my ideas and public statements, and rectifies any misinterpretations made by others during my short visit to Bosnia. I hope that any difference in opinion will be accepted in a scientific manner. These are observations and analyses, which, to the best of my knowledge, are fair.

NAMES OF THE PYRAMID HILLS AND MOUNDS AT VISOKO

	<i>Local Name</i>	<i>New Bosnian Name</i>	<i>International name</i>
1.	Visočica	Bosanska Piramida Sunca	Bosnian Pyramid of the Sun
2.	Plješevica Hrašće	Bosanska Piramida Mjeseca	Bosnian Pyramid of the Moon
3.	Bučki Gaj	Piramida bosanskog Zmaja	Pyramid of the Bosnian Dragon
4.	Četnica	Bosanska Piramida Ljubavi	Bosnian Pyramid of Love
5.	Krstac	Hram majke Zemlje	Temple of Mother Earth
6.	Vrela(New) ³	Šesta Piramida	Bosnian Sixth Pyramid

In this report I am using the local names because they appear as such on maps and in the older literature. Gradually the new Bosnian and international names will take over.

Photo credits are mentioned at the bottom right side of the image. The absence of a credit means it was photographed by the author.

³ Recognized on the map by Višnja Dobrić; with the same orientation

PYRAMID RESEARCH

Pyramid research is a branch of pyramid studies which investigates terms, concepts and properties of pyramids:

Terms: The terms expressing the meaning of pyramids go a long way back to Ancient Egypt where each pyramid had name; examples: *The horizon of Khufu, Menkura is divine, Beautiful are the places of Unas*. Each of these names was followed by a pyramid determinative \triangle , which is the hieroglyph for pyramid and is pronounced 'mr. We have more than 100 royal pyramids from the 3rd to the 13th dynasties all having names pointing at religious or great matters.

In Arabic the term is 'هرم', pronounced 'haram, it means the ultimate age or size.

In Greek, Latin and English, I refer to the Dictionary.

Pyramid (pi'rämüd), *sb.* late ME. [orig. in form *pyramis*; a. L. *pyramis*, pl. *pyramides*. a. Gr. *πυραμῖς*, pl. *πυραμίδες* (perh. of Egyptian origin).] 1. A monumental structure built of stone or the like, with a polygonal (usu. square) base, and sloping sides meeting at an apex; *orig.* and *esp.* one of the ancient structures of this kind in Egypt 1555. 2. The form of a pyramid; in *Geom.* a solid figure bounded by plane surfaces, of which one (the base) is a polygon of any number of sides, and the other surfaces triangles having as bases the sides of the polygon, and meeting at a point (the vertex) outside the plane of the polygon. late ME. †3. *Arch.* Any structure of pyramidal form, as a spire, pinnacle, obelisk, etc. Also applied to a gable. -1716. 4. Any material thing, or pile of things, of pyramidal form 1570. b. *Gardening.* Applied (*orig. attrib.*, hence also *simply*) to a fruit-tree, etc., trained in a pyramidal form 1712. 5. *fig.* (from prec. senses) 1593. 6. *Cryst.* A set of faces belonging to a single crystallographic form, and, if symmetrically developed, meeting in a point 1748. 7. *loosely.* A plane figure or formation suggesting the profile of a p. 1589. b. *Billiards. pl.* A game played (usu.) with fifteen coloured balls arranged in a triangle, and one cue-ball 1850. 3. What needs my Shakespear...that his hallow'd reliques should be hid Under a Star-ypointing P.? MILT. 4. Smithfield blazing with pyramids of law-books SWIFT. 5. An unsteady and sharp-pointed Pyramid of power 1628. *Comb.:* p.-rest (*Billiards*), a cue-rest the head of which is arched so as to allow it to be placed over a ball which would otherwise be in the way; -spot, the spot on a billiard-table where the apex of the p. is placed, between the centre and the top spot. Hence **Pyramidist**, one who investigates or is specially versed in the structure and history of the Egyptian pyramids.

THE SHORTER OXFORD ENGLISH DICTIONARY ON HISTORICAL PRINCIPLES

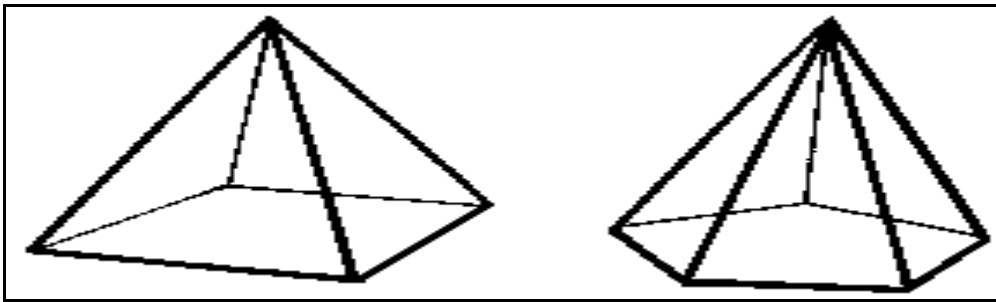

SQUARE AND POLYGON BASES OF PYRAMIDS

The flexibility of the meanings comes in our modern English by added words, prefixes and suffixes. This can change the geometrical shape without changing the pyramid category: examples are true pyramids, step pyramids, bent pyramids, truncated pyramids and pyramid like monument.

Added words, prefixes and suffixes to the word pyramid explain the material used in their construction and indicate whether they are manmade or natural without changing the shape: examples are stone pyramids, brick pyramids and natural pyramids (pyramid hills).

Added words, prefixes and suffixes to the word pyramid can also explain the pyramid function without changing their shape or material: for example, funerary pyramid, ritual or satellite pyramids.

Tumuli, because of their sepulchral meaning, are sometimes confused with funerary pyramids. But some mounds which are not burial places are erroneously called tumuli.

Pseudo pyramids are structures that are referred to as pyramids but do not possess the pyramid properties mentioned below. Ziggurats fall under this category.

CONCEPTS:

The concepts in pyramid research are monumental, historical and religious.

MONUMENTAL

This concept involves rich resources, a wide scope of requirements, complex knowledge of many branches of science and available building capabilities.

The builders have to define the aims of the project and figure out the available possibilities. Then they have to consider the building site, calculate the dimensions of the monument and estimate the time it will take to be completed.

Surveyors and astronomers will set the pyramid plan. Times of the equinox and solstice have to be considered for orienting the pyramid base to the cardinal points. Sighting instruments will be needed to monitor the building process.

Building material and tools have to be provided before the actual building. Skilled and ordinary workers have to be recruited. An administration capable of running the project has to be assigned.

The completed project will realize the pyramid properties and will serve the purpose for which it was built.

HISTORICAL

Historical concepts tell the story of the monument from the time the building began to the present. It should account for the date of the culture or the civilization and the owner. This

concept accounts for the history of construction and the degree of completion. It can also account for the duration of serving the purpose for which it was built and the following phases of neglect and destruction. The historical concept should account for the discovery, restoration and publications.

RELIGIOUS

The local stories and folklore repeated by the local inhabitants may contain some roots that go back into the past. The local name of the monument surviving at present may point to early or social rituals. Generally speaking, the religious concept is the reason for the existence of the pyramid and the function it serves.

PROPERTIES:

Thus a pyramid with a square base (in our terminology it is called a *true pyramid*) is geometrically founded on 11 straight lines; 4 lines are the base; 2 lines are the base diagonals; 4 lines are the corners; and 1 line is the height (from the crossing of the base diagonal to the apex). This perfect form of a pyramid has to have the base diagonals of equal measurement and the corners of equal length. It has to be neither sharp nor blunt.

In some cases where the pyramid is founded on an area which has not or cannot be leveled, but maintains the true pyramid appearance, the 11 line rule can be disregarded.

A pyramid is usually composed of a superstructure which has a core, nucleus and outer facing and a substructure which is beneath or within the superstructure.

Pyramid properties have common and regional features.

COMMON

The common features are the aesthetic geometry, the stability and generally the orientation.

REGIONAL

The regional features are characteristics which stand out at each region. Thus we have Egyptian, Mexican, and Bosnian pyramids.

TUMULI

Tumulus (*tiŭ'miŭls*). *Pl. -li* (-ləi). 1686.
L., deriv. of root *tum-* of *tumere* to swell,
tumor. | An ancient sepulchral mound, a barrow.

THE SHORTER OXFORD ENGLISH DICTIONARY OF HISTORICAL PRINCIPLES

In the published literature there appears to be a mix-up between geometrical shapes: pyramid, tumulus, mound, stupa, barrow, pseudo pyramid and ziggurat.

The dictionary tells us that the tumulus is an ancient burial mound. I consider the geometry of the latter to be conical, with a roundish base, no corners and curved top.

The word tumulus covers the forms stupas and barrows.

The earliest tombs in Egypt were independent tumuli. In the tomb development tumuli were maintained imbedded in mastabas and pyramids. A tumulus imbedded in mastaba K1 at Beit Khallaf dating to the 3rd dynasty (BC 2700) is clearly visible from destruction on the outside. The Step pyramid at Saqqara has another tumulus which can be seen at certain places in the substructure.

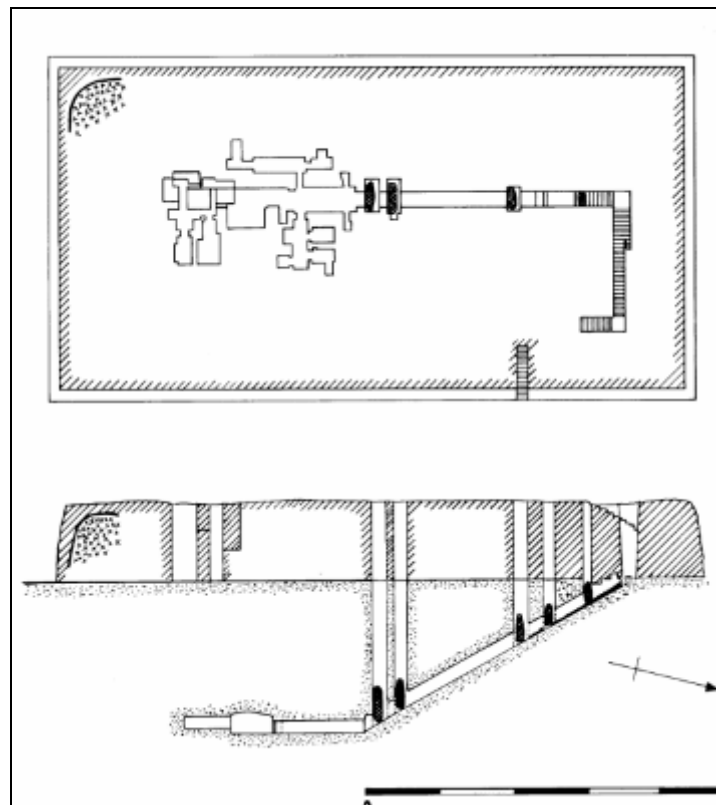

Nabil Swelim 1983

Stupa is a tumulus type of Buddhist structure found across the Indian subcontinent and other parts of Asia. The Great Stupa at *Sanchi* dates to BC 400 -100.



Photo copied from the internet

The *Mankiala stupa* was built on the legend of Buddha's offering of his body to seven hungry tiger cubs. Note the vegetation on the upper part and the recess panelling on the construction of the plinth.



Photo copied from the internet

The largest tumulus in central Europe is named *Grossmugl*, in Lower Austria (BC 500-600). It has a roundish base, a diameter of 55 m, flattish sides, and a present height of 17 meters. Vegetation covers this structure. Such mounds are not pyramids.



Photo copied from the internet

Barrows of the *Silla* kings dating around AD 300 are the most famous tumuli in Korea. Vegetation covers their structures.



Photo copied from the internet

PSEUDO PYRAMIDS

Some monuments were never intended to look like a pyramid from the start; but they have been introduced into the literature as pyramids. Ziggurats could be included in this category. The Pyramid at *Cholula* called; "The Pyramid of *Tipanipa*" in Mexico is the largest "Single Base Pyramid" in the world. It is dedicated to the serpent *Quetzalcoatl*. The height is 55 m and covering an area of some 25 acres, the pyramid was begun in Pre-Classic times and enlarged at least four times.

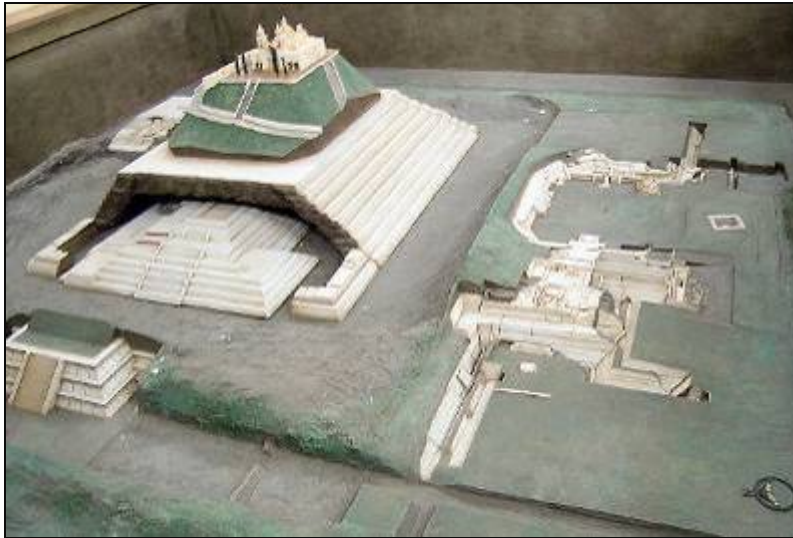

Photo copied from the internet

The largest standing monument of that category is a 700 m long mud brick structure surrounded by 25 others known as the pyramids of *Tucume*. They are dated to the *Lambayeque* culture in Peru. This culture ended with the Spanish invasion (AD. 1532). Among the properties of the *Tucume* pyramids were: ascending ramps, passages which turned at right angles, palaces on their tops, and one small temple for human sacrifice in the valley of *Lambayeque*.



Photo copied from the internet

Another such monument is on the Mississippi near Collinsville, Illinois, USA: a large mound in the city of the sun *Cahokia*. This mound dates to about A.D. 1200



Photo copied from the internet

Ziggurats

Other forms of pseudo pyramids are the ziggurats of Mesopotamia dating to B.C. 2000. They are large solid mud-brick stepped towers. Stairways lead to the top where there was a small temple.



Photo copied from the internet

The most common parameters of a pyramid are in Egypt, some of which will be guide lines in pyramid research.

PYRAMIDS IN EGYPT

In Egypt the historical knowledge gives us a good background for pyramid studies. From this knowledge we have learnt that:

There are Funerary pyramids, Ritual pyramids, Benbens and pyramid like monuments. The main pyramids are the Funerary ones. Each Funerary pyramid was built during one reign, from the third to the thirteenth dynasties (B.C. 2800- 1900). It stands within a complex composed of:

- A valley temple
- A cause way
- A funerary temple
- A subsidiary pyramid
- A temenus wall
- Several boat pits

Moreover every Funerary pyramid was expected to fulfill a number of religious requirements namely:⁴

- The cult of the upper world, the Sun god Ra^c: as primeval hill; in the superstructure.
- The cult of the netherworld, the god Osiris: the god of resurrection; in the substructure.
- The astral cult: by corridors pointing to the circumpolar region.
- The cult of the dead king: rituals performed by priesthoods in the pyramid complex.

These features belong to Egyptian pyramids only. They are not applying to any other pyramids outside Egypt and the Sudan.

In spite of all the knowledge, we are still researching how the pyramids of Egypt were:

- Planned
- Supplied
- Built
- Administrated

Consequently pyramid research in Egypt, as it is in Bosnia, is still underway.

MAIN COMPONENTS OF A PYRAMID

The pyramid edifice is composed of a superstructure and a substructure:

THE SUPERSTRUCTURE is a free standing construction built of stone or bricks. It has a volume equal to the area of the Base times one third of its Height; i.e., if a square base ($B^2 \times H/3$)

The superstructure is composed of a core, nucleus and an outer facing:

- **THE CORE**, 1, 2 (in the figure) is the innermost part of the pyramid and could contain a solid construction, a natural feature, an earlier funerary shape, or an older pyramid.
- **THE NUCLEUS** 3, 4, 5 (in the figure) is the principal construction built in a few different ways: accretion layers, embankments and a fill, solid masonry or cross walls, etc. It is the penultimate project in the construction of the pyramid.

⁴ These are not rigid and not necessarily found 100% in every pyramid.

- **THE OUTER FACING 6, 7, 8** (in the figure) is constructed of the finest material available and covers the nucleus to complete the ultimate pyramid shape.

Generally, not in a detailed way, these features belong to all pyramids. They loosely apply to other pyramids outside Egypt.

THE SUBSTRUCTURE A, B, C, D (in the figure) is the complex of corridors and chambers tunneled beneath or built within the superstructure. The substructures of pyramids outside Egypt differ.

A PYRAMID SECTION LOOKING WEST

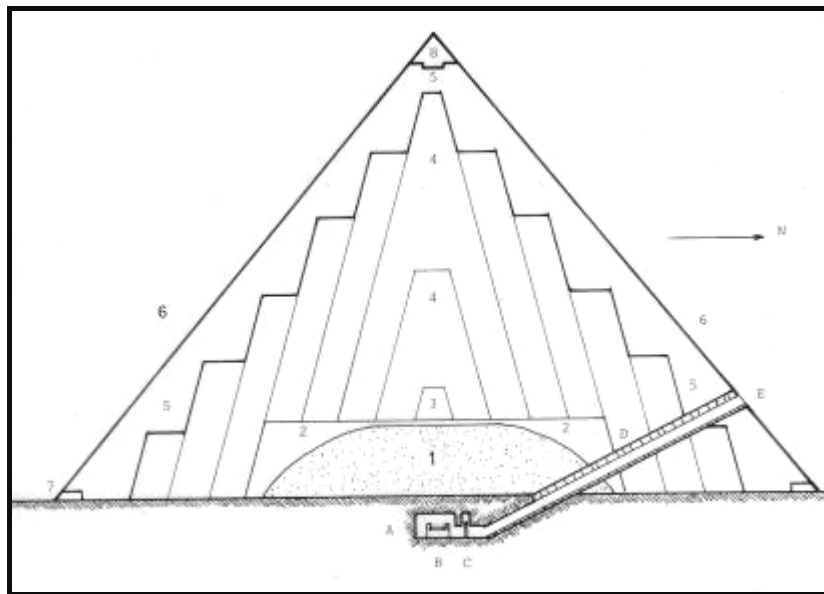

Nabil Swelim 1987

SUPERSTRUCTURE

- | | |
|----------|---|
| 1 | Tumulus (part of the core) |
| 2 | Retaining Mastaba (part of the core) |
| 3 | Medulla (part of the nucleus) |
| 4 | Accretion Layers (part of the nucleus) |
| 5 | Packing Steps (part of the nucleus) |
| 6 | Casing (part of the outer facing) |
| 7 | Orientation Course (part of the outer facing) |
| 8 | Pyramidion (part of the outer facing) |

SUBSTRUCTURE

- | | |
|----------|----------------|
| A | Burial Chamber |
| B | Sarcophagus |
| C | Portcullis |
| D | Polar Corridor |
| E | Entrance |

The superstructure was built to achieve perfection of:

1. Geometry
2. Stability
3. Orientation

GEOMETRY

In principal an ideal pyramid in Egypt is a structure with square or rectangular base and 4 triangular sides the tops of which are meeting at the apex. This meeting point is over the base diagonal's crossing. This structure is founded on the 11 straight lines mentioned above.

STABILITY

The pyramid has to be designed neither too sharp (tall) nor too blunt (short), actually to the height resulting from the angle of repose. In other words, the angle of repose is the angle a tumulus or pyramid forms with the ground.



Photo copied from the internet

ANGLE OF REPOSE OF A TUMULUS CREATES THE HEIGHT

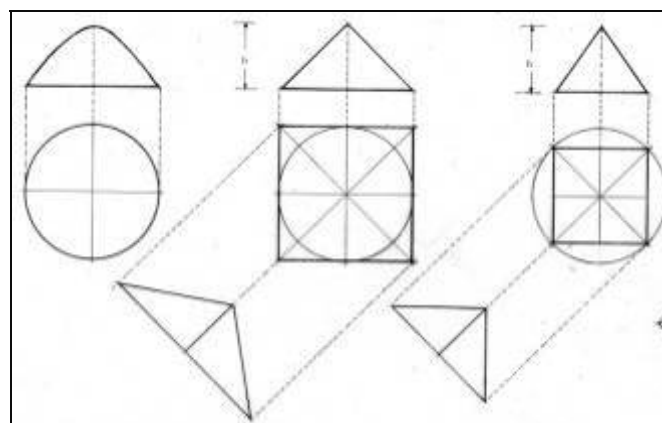

Nabil Swelim 1983

THE HEIGHT OF THE TUMULUS BECOMES THE REFERENCE TO THE HEIGHT AND SHAPE OF THE PYRAMID⁵

Nature has offered mankind a blessing factor in soil mechanics, stability and height. The modern name of this factor is the angle of repose. It is explained simply by the maximum slope of material possessing friction and weight. It results in a relationship between the base of a mound, pyramid, ramp or any construction and its height. These advantages were learnt in pre and proto dynastic Egypt (BC 3200-3000) by constructing tumuli with a roughly round based mounds. An important lesson was not to exceed this height. Such tumuli are still preserved imbedded in Mastaba K1 at Beit Khallaf (see fig page 7), in the Step Pyramid at Saqqara (see photo on page *) and elsewhere.⁶ The following development in the early Old

⁵ N.Swelim, *The Brick Pyramid at Abu Rawash Number I by Lepsius a Preliminary Study*, Alex, 1987, 68.

⁶ N.Swelim, *Some Problems on the History of the Third Dynasty*, Alex, 1983, 92.

Kingdom BC 2800, builders designed their pyramids to have a base length equal to the diameter of the tumulus. Then in BC 2600 the base diagonal of the pyramid became equal to the diameter of the tumulus, this made it look more elegant. The height of the tumulus became the reference in all cases until the late Old Kingdom BC 2400. Looking at the shape of the pyramid; it becomes sharper along the axis and blunter along the diagonal (see drawings by Simatovic (on page *). Naturally the height is the same. In the figure above notice that the elegant shape along the axis of the middle figure is identical to the shape along the diagonal of the right figure.

ORIENTATION

Most of the pyramids are oriented to the cardinal points by their sides, in a perfect manner but some are not so perfect for various reasons. A very few are oriented by their corners.



Copied from an unidentified publication

THE GREAT PYRAMID OF KING KHUFU

In the photograph above an aerial view of the pyramid of King Khufu (Cheops) of the 4th dynasty at Giza dates to BC 2600. It represents the perfection of geometry, stability and orientation. Set on an accurately leveled area, it measures: b 230 m, h 148 m, Volume 2.6 million m³.

OBSERVATIONS

Visočica and Plješevica Hrašće have outstanding features; they are spectacular and beautiful at the same time. From the point of view of pyramid research they are rightfully named pyramid hills; their monumental concepts are discussed here. While the historical and religious concepts are still to be investigated. Their common properties are similar but the regional are completely different. This gives them a highly individual character of being two examples of Bosnian pyramid hills. My analyses below will discuss the properties in more detail.

From our observations we may learn about their monumental concepts.

PYRAMID HILL VIŠOČICA

At the pyramid hill **Višočica** let's discuss the elementary pyramid components:

- The superstructure
- The substructure
- Outstanding features

THE SUPERSTRUCTURE

Here is an attempt to figure out some preliminary information on:

- Reading maps and aerial views
- The relative heights of Visočica
- A proportional outline
- Masonry
- Mortar

READING MAPS AND AERIAL VIEWS OF VIŠOČICA

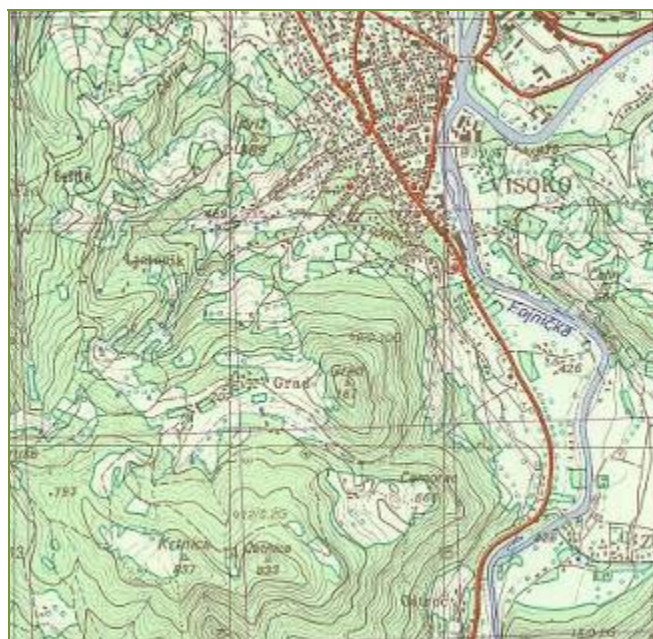

The local maps of Visoko are rich with data which can furnish us with preliminary approximations. They paint a general picture of the situation. Though the figures are not precise, they can be helpful until a professional survey has been completed. Very informative also is the

3D satellite documentation presented by Idriz Balihodžić.⁷ They have helped me shed a dim light on three items:

- Sides of Visočica
- Relative heights of Visočica
- Corner measurements of Visočica

THE SIDES OF VIŠOČICA

Semir Osmanagić explains a similarity with the concept of Mexican pyramids by platforms followed by slopes:

“The geomorphic characteristics of the mound suggest that after periods of climbing under the same angle one reaches a flat plateau, approximately 2.5 meters wide, and then another steep area follows, followed by another plateau, with the pattern repeated all the way to the top of Visočica”.⁸ I believe a profile of Visočica drawn by a surveyor is necessary to illuminate this observation.

THE NORTH SIDE

The N side comes closest to perfection; its plane is roughly an equal sided triangle of: **250 - 230** m in length and 60° . When one looks from ground level southwards along the NS axis, it appears as if it had two 45° and 90° at the apex.

THE EAST SIDE

The E side demonstrates a little less perfection, the plane has 2 sloping waves or channels and protrusions in between.

THE SOUTH SIDE

The S side is separated from a hill to the south by a valley in which the semicircular track runs. This side becomes incomparable with the planes on the N and E sides. I believe that there is a possibility that the S side was destroyed, unfinished or intended as such. The upper part of this side is bulging out and slopes towards the truncated plateau.

THE WEST SIDE

The W side is regular for a distance of 40 - 50 m along the NW corner line, but the plateau merges with it beyond that. The width of this plateau goes as far as the S side at contour 600 m., there is no SW corner. The photograph below shows this feature clearly by the accumulation of snow on the connecting plateau.

⁷ Idob69@yahoo.com

⁸ Reference # 3; *Scientific Evidence about the Existence of Bosnian Pyramids*, July 2006, p 11.



The plateau joins the pyramid hill on the west side at a level of 600 m above sea level.



Photo from the Foundation

In winter Visočica the plateau are covered with snow they join on the west side of the pyramid hill

THE RELATIVE HEIGHTS OF VISOČICA

Let's proceed by reading the height of surroundings below the plateau at the top of Visočica (767 m above sea level).

- The valley below to the N is 500 m above sea level.
- The valley below to the E is 426 m above sea level.
- The plateau on the W side joins Visočica at 690 m above sea level.
- On the S, are: a small valley 600 m and a hill 665 m above sea level.

Thus Visočica looks:

- 267 m high on the N side.
- 341 m high on the E side.

- 77 m high on the W side.
- 167 - 102 m high on the S side.

CORNER LINE MEASUREMENTS OF VISOČICA

An attempt to figure out the actual corner measurements of Visočica cannot be reached at present. Visočica is a truncated pyramid hill with a plateau at the top, it is inclined to the SE, and thus the apex is missing⁹ and the corners shall vary in measurement. We shall be unable to come to any correct figures until the position of the apex, and the level of the hypothetical base has been fixed.

To get an idea of approximate measurements of the corner lines it necessary to make further readings of the map by counting the contours upwards:

- The NE corner line takes a straight course form contour 500 m to contour 750 m i.e. **the corner length is 250 m.**
- The NW corner line takes a straight course form contour 570 m to contour 760 m i.e. **the corner length is 230 m.**
- The SE corner line covers the distance between the intersections with contour 600 at the small valley to contour 760 m i.e. **the corner length is 160 m.**
- The SW corner line does not exist.

From these approximations we can see how difficult it would be to try to estimate the volume of Visočica.

⁹ None of the pyramids of Egypt have been found with the apex intact. Tens of pyramidions have been found fallen or destroyed at their pyramid site.

PROPORTIONAL OUTLINE OF VIŠOČICA

Dr. Ivan Šimatović (Croatia), has drawn a proportional outline of Visočica in 2 documents.¹⁰ Though in reality there is no base, he suggests a hypothetical one which is rectangular. This helped him show how the pyramid looks, in proportion, from a distance, towards: the longer axis, the shorter axis and the diagonal. In that respect, the reality and the outline support each other on the N side, E side and the NW corner. The topography of the site however prevents such view from the S side, W side and the SW corner is destroyed. In his articles he made calculations showing sophisticated relationships, which I recommend.

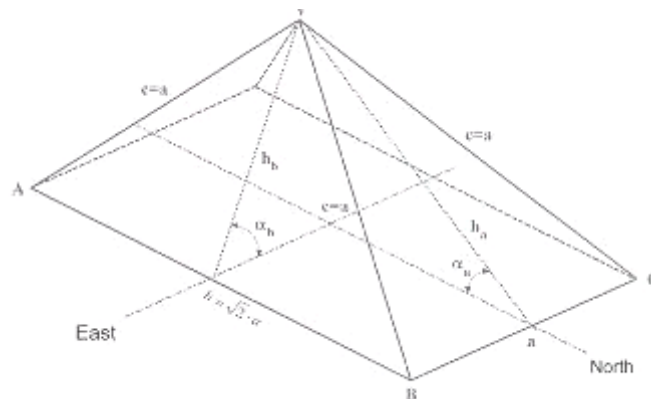

Ivan Šimatović Jan 2007

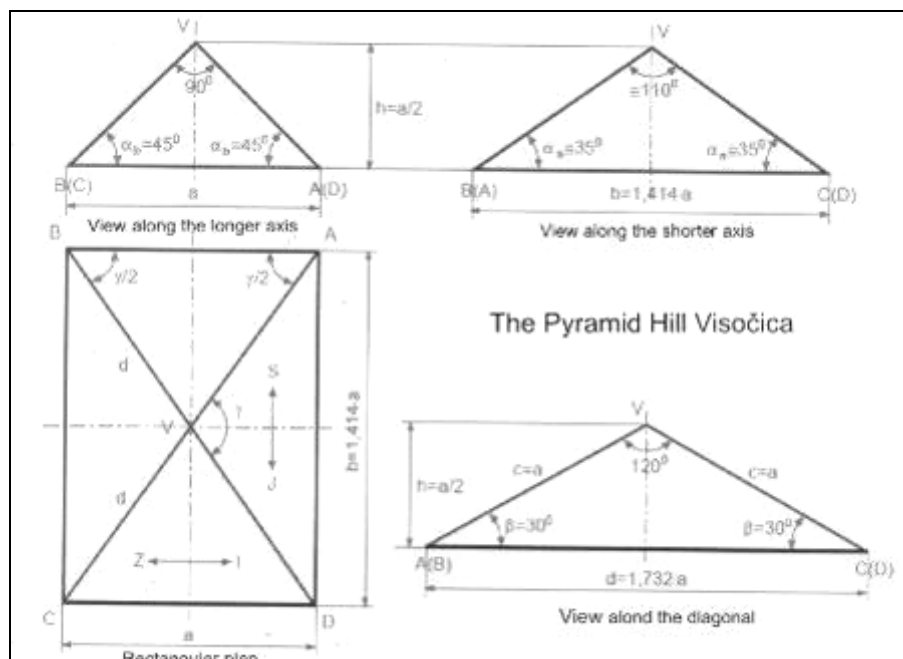

Ivan Šimatović Jan 2007

¹⁰ Reference # 6; *Documents ...etc of Visoko-Sarajevo, September 01, 2007.* and: *Određivanje geometrijskih elemenata visočke Piramide Sunca, 30/1 /2007.* I have added bearings on the upper figure and a title and comments concerning the view on the lower figure.

The hypothetical base of Visočica is rectangular like the step pyramid at Saqqara and has an appearance, by looking towards the axis on the N and E sides and the NE - SW diagonal; is similar to the Red pyramid at Dahshur.

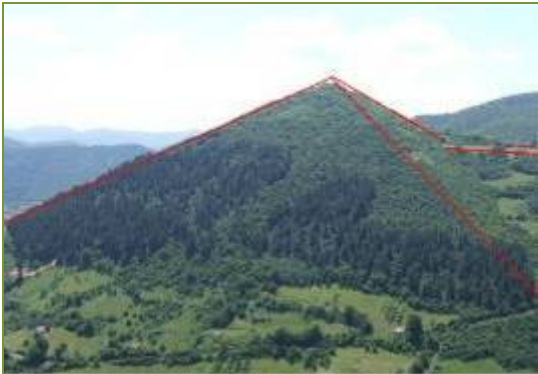

Photo from the Foundation
THE N AND W SIDES OF VISOČICA



THE RED PYRAMID AT DAHSHUR FOURTH DYNASTY (BC 2600)



THE STEP PYRAMID AT SAQQARA THIRD DYNASTY (BC 2700)

MASONRY

In the report of July 2006, only brief accounts of the results of the investigations are mentioned. The geological-sedimentary analyses have not shown for certain whether:

“the layered sandstone and breccia blocks, ...were manually processed and/or cut to fit the required dimensions.”

These are fundamental issues which must be scientifically studied and accepted. I suggest that the Foundation selects some of the original copies or abstracts on this issue and have them published in the *Journal*, which I propose at the end of this report.

The results of exposing the rock surface of this pyramid hill at some excavation sites are seen in the following photographs:

BEDS OF CONCRETE LIKE STONE

- Horizontal beds of concrete-like-stone at: Sonda 1, 2 (photo gallery).
- Areas paved with sloping beds of concrete-like-stone at: Sonda 5, 10, 11 (photo gallery).
- Impressive sections of thick beds of concrete-like-stone at: Sonda 12 (photo gallery).

The consistency of the existence of concrete-like-stone at so many sites tends to tell us that the nucleus was shaped with that material. Wide areas have been unearthed showing the slope of the pyramid side and are suffering from cracks.



SONDA 1 (PHOTO GALLERY)



SONDA 2 (PHOTO GALLERY)



SONDA 5 (PHOTO GALLERY)



SONDA 10 (PHOTO GALLERY).



SONDA 11 (PHOTO GALLERY).



SONDA 12 (PHOTO GALLERY).



INCLINED AND RECEDING CONCRETE LIKE BEDS AT SB 1



All previous 8 photos by the Foundation INCLINED AND RECEDING CONCRETE LIKE BEDS CREATE THE PYRAMID SHAPE AT SB 1



Photo by Salwa CONCRETE LIKE STONE JOINING THE SOUTH SIDE OF VIŠOČICA.

A STRATUM OF CONCRETE LIKE STONE

We need also to be reminded that the volume of masonry is immense. But there is an observation which has to be studied by geologists. The concrete like stone bedding which I have seen at the nucleus of Visočica is similar to that of the roofing of tunnel KTK and to that seen in section overlooking the south bank of the river Bosna. Both are one kilometer NE. Could they be extensions of the same stratum?



NUCLEUS OF VISOČICA.



ROOFING OF TUNNEL KTK.



3 Photos by Salwa
OVER LOOKING RIVER BOSNA.

BRECCIA

A limited area of this stone was unearthed on the north side. Otherwise this kind of stone is found in the vicinity as stone objects at a few places.



LARGE SLABS OF CONGLOMERATE LYING SIDE BY SIDE AT A SLOPING ANGLE ON THE NORTH SIDE OF VISOČICA, SONDA 4.



A CUBICAL BLOCK ON THE PLATEAU JOINING THE W SIDE OF VISOČICA. THERE ARE SIMILAR ONES ON THE PYRAMID.



A BLOCK HOLLOWED INTO A BASIN ON THE PLATEAU JOINING THE W SIDE OF VISOČICA.



A CONGLOMERATE LID OF A SARCOPHAGUS OUTSIDE THE MUSEUM AT VISOKO. PROBABLY FROM THE SAME SOURCE.



UNFINISHED CONGLOMERATE VESSEL AT THE CHOCOLATE FACTORY WHICH IS PROBABLY FROM THE SAME SOURCE.

MORTAR

In, *Documents ...etc of Visoko-Sarajevo, September 01, 2007*; questions # e:

I think by saying (connecting material) we are talking about mortar and if it is similar to that used at the pyramids of Giza?

Generally speaking there are 2 kinds of mortar used in the Egyptian pyramids:¹¹

- The core and nucleus; if of mud brick, the mortar is wet mud and sand; if of stone, wet clay, crushed limestone and gypsum. These mortars were exposed and collected insects and pollen, which have revealed information on the contemporary flora and fauna.
- The mortar used for fine lime stone outer facing in both cases, was hard white gypsum prepared in a kiln with the right temperature to lose more water particles.

Such analyses are needed to compare with other historical structures in Bosnia where the composition of such mortar is available. The studies of ancient kilns are to be considered.

¹¹ For the results of mortar analyses see, Lucas, *Ancient Egyptian Materials*, London 1926.

THE SUBSTRUCTURE

Dr. Aly Barakat (Cairo) mentions a local account among the inhabitants of the area of Visoko, concerning an entrance at the plateau of the truncated top. This account tells us that there are a stairway and chambers connected to tunnels.¹² This entrance will remain uncertain until it has been found archaeologically.

The geophysical report by "LGA Bautechnik GmbH Civil Engineering Projects"¹³ (Germany), has detected anomalies between 0.8 meters and 5 meters below the surface of sites they investigated. This will be a good start but short of the data needed for much deeper anomalies and the architectural composition of Visočica. As the case is with geophysical investigations these anomalies are not conclusive and need archaeological digging to follow up. Seismic methods have the means of detecting anomalies at great depths.

More important is the early work of the Foundation in Aug. 2005, by Geological drilling,¹⁴ which led to some interesting conclusions. They refer to the existence of inner chambers: "The builders created chambers within the pyramid. This explains the presence of vertical marl instead of horizontal."¹⁵ Naturally, marl should come in horizontal layers as seen at Plješevica Hrašće; vertical marl however, was found on the western side of the pyramid where the plateau joins. According to geologist Nadja Nukic, vertical marl indicates huge construction works. But we need geological consultations on this issue.

Numerous statements of the military personnel stationed on the Pyramid itself and subjected to heavy shelling, have reported unusual ground vibrations, echoing and ground movement whenever the mound was hit by the artillery fire in the course of war operations in Bosnia 1992-95. This acoustic evidence suggests that cavities/chambers may indeed exist within the structure.¹⁶

If the Tunnels Ravne and KTK are indeed connected to the pyramid hill substructures they have a parallel at Saqqara.

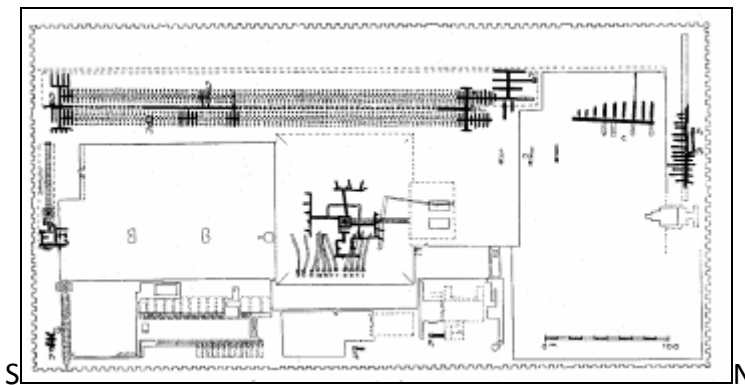

J Ph Lauer 1962

THE SUBSTRUCTURES OF THE STEP PYRAMID COMPLEX AT SAQQARA ARE GALLERIES THAT ADD UP TO 5 KILOMETERS IN LENGTH?

¹² Reference #7 in Arabic.

¹³ Report BBMT0600183 date: February 7, 2007; reference # 6, *Documents ...etc of Visoko-Sarajevo, September 01, 2007, I-d*; It would be of scientific value to publish the 'core logging' and 'a profile of the drill core' in the suggested *Journal*.

¹⁴ Reference #1 Semir Sam Osmanagich, *Bosnian Valley of the Pyramids*, Maunagic, 2006, 33-60.

¹⁵ Ibid Page 58

¹⁶ Reference # 3, *Scientific Evidence about the Existence of Bosnian Pyramids*, July 2006 12; reference # 6, *Documents ...etc of Visoko-Sarajevo, September 01, 2007, I-h*).

OUTSTANDING FEATURES AT VISOČICA

1. Looking along the NS and the EW axis of the pyramid shape of the Visočica hill, I see the largest pyramid in the world and looking from the opposite sides the shape is distorted. See relative heights above.
2. The N side is perfect and E side comes close to perfection.
3. The orientations setting to the cardinal points are remarkable.
4. The debate of *human intervention* vs. *Natural* or geological formation is explained by dr. Aly Barakat in an answer to dr. Sejfudin Vrabac.¹⁷ Prof. Vrabac had sent a voluntary message to Aly and me. He said: "During 2006, I was leader of the Team for geological investigation of Visočica near Visoko. The Team was composed of six doctors and two masters of geological sciences. Our reliable scientific evidence is: 'Visočica is the natural hill consisted of Miocene clastic sediments' ... Please, when you write about Visočica you should have to know the reliable geological evidence. If you want to know any more information I will give you that with pleasure". I accept his statement and have no doubt about the reliability. I am putting it here in my report. To complete his generalised statement I find necessary to add more precise points. I replied with the following "... I will need some specifics, kindly inform me: concerning the dates of your investigation, the method that led to this conclusion and the locations of the samples you collected. The pyramid hills are so vast so I need also a reason for generalizing your conclusion". I am waiting for his reply!

¹⁷ Here are some extracts from Dr. Aly Barakat's reply to Prof. Vrabac;

I agree with you that the main mass of the hill is natural breccia/conglomerate of the Miocene age. But I believe that it was modified by man to be a pyramid.

You will probably agree that the natural processes cannot create the regularity of the northern side which is a perfect triangular face. I suggest that you go up on the northern or eastern side of the hill. You will find that the natural thin shale layer which is intercalated with the breccia/conglomerate rock had been removed. This has exposed a white and smooth hard face.

More features are:

- White slabs are arranged on these two faces following the general slope.
- Perfect shaped rectangular blocks of hard conglomerate must have been brought from outside the area. They are found on the plateau behind the hill.
- Small block of cubic shape were found during the excavations last year.
- The western side is straight and decomposed; the construction material can be observed midway climbing to the top. A feature was reported by Dr. Dario Andretta (Italy) in June 2006.
- In 1984, *Pavao Andelic et al* published a book entitled "*Visoko i okolina kroz historiju*". They mentioned that the hill is natural but there are human activities which contributed to the shaping of the hill. They also report that the site had not been studied archaeologically; this means that the understanding of the full story and history of this hill is incomplete.
- In conclusion, I believe that the hill was modified to the pyramid shape by an ancient civilization(s). Tectonic and human destruction contributed to the irregularity of some faces of the hill. From the first glance at the topographical map, you will find the derange system of the site and recent tectonics reflections in the nearly acute channels. Consider also in your study human habits towards antiquities all over the world.

As a geologist, you have the right to claim that the hill was never touched by man and has remained the same since it was created; while other geologists- e.g. Mensur Omerbashich in 2007, have published: *Bosnian "Pyramids": Hills shaped by Romans*.



5. Visočica shows evidence of a filled area with a tiled terrace seen in section, between the large conglomerate blocks of breccia at Sonda 4 and the beds of concrete like stone at Sonda 5. If this area is investigated it should tell us about patching up cavities in the nucleus.



Photo from the Foundation

6. An unearthed area of the NE corner line at Sonda 17 Brid. One can see how nicely the N side turns to become the E side creating a 90° angle between the 2 sides. This corner length is 250 m from the plane to the plateau and we have 3 corners. This is amazing; I would really like to know of a similar example created by nature at this scale. And the comments of geologists who ignore this fact.

PLJEŠEVICA HRAŠĆE HILL

At the pyramid hill **Plješevica Hrašće** let's discuss the elementary pyramid components:

- The superstructure, the work is actively underway.
- The substructure, no information has yet been found.
- Outstanding features.

THE SUPERSTRUCTURE

Accordingly we shall discuss the monumental concept of this pyramid hill:

- Reading maps and aerial views
- Terraces covered with tiles
- The plateau.

READING MAPS AND AERIAL VIEWS OF PLJESEVICA HRAŠĆE

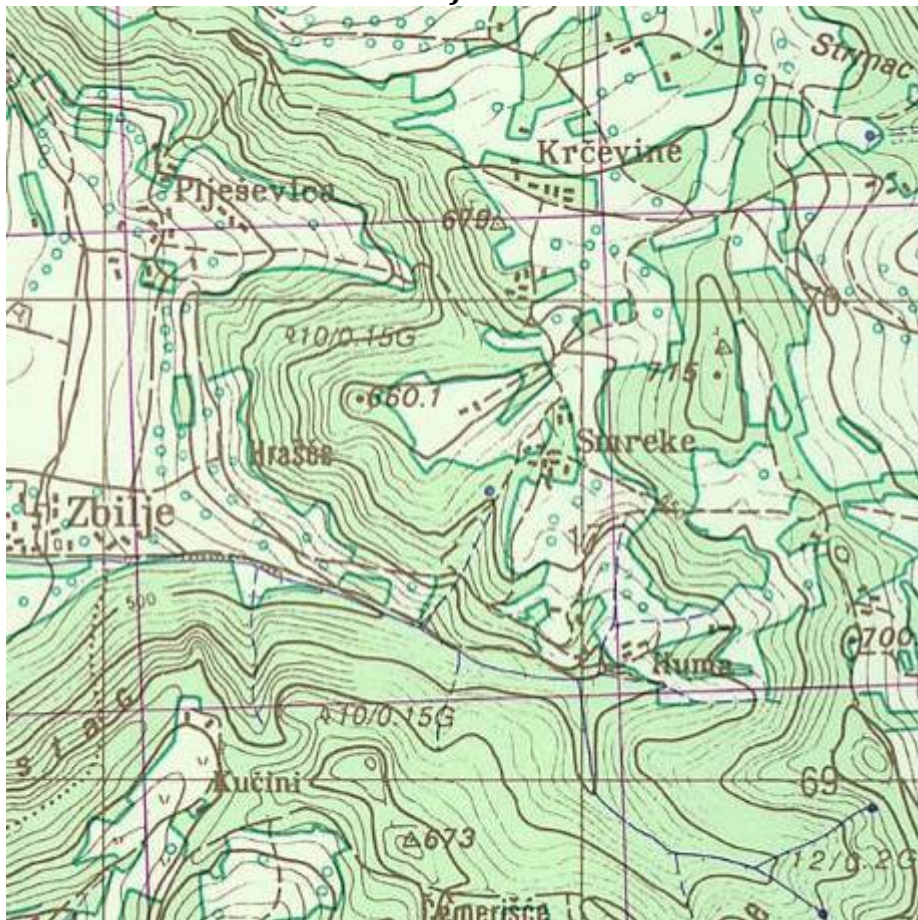

Looking SE from Visočica or the town of Visoko, one sees: the N and W sides of the pyramid hill Plješevica Hrašće. At the top is a plateau 660 meters above sea level. The village of Zbilje, to the W is 450 meters above sea level. Thus the relative height of the monument from that angle is **210 m**.

The map does not show the corners of the pyramid as well as seen at Visočica and the new pyramid new pyramid hill Vrela. The orientation of the N and W sides fairly adhere to the cardinal points; whereas the south side takes a South Westerly direction and the E side is merged in the plateau of Smraka reaching the height of 715 meters above sea level. The N side bulges out.

Geological remarks in Ali Barakat's report state that:¹⁸ "The pyramids Moon and Dragon are natural hills with human adding or removing, but this human intervention is not effective, consequently it is difficult at present to give a correct opinion, and the initial results are not encouraging. The presence of land mines limits the investigations."

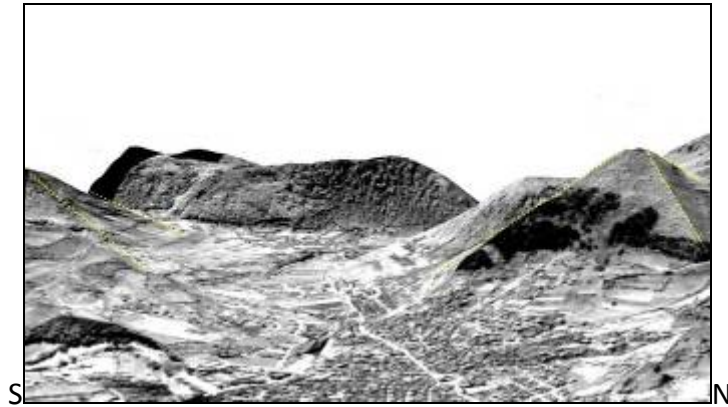

Photo from the Foundation

THE VALLEY OF THE PYRAMIDS AT VISOKO LOOKING SW



Photo from the Foundation

PLJEŠEVICA HRAŠĆE PYRAMID HILL LOOKING EAST

TERRACES COVERED WITH TILES

The sites on Plješevica Hrašće which have been investigated on the west side are consistently showing thin beds of clay or terraces nicely paved with tiles. They are set in horizontal layers one on top of the other, slightly declined inwards E and leftwards N directions.

Evidence of a tiled terrace is rarely seen at Visočica; I have seen it at one site in section,¹⁹ but they prevail at Plješevica Hrašće and mound Toprakalia. I was told by Semir Osmanagich that:

¹⁸ Reference # 7; a translation from the Arabic text

¹⁹ See above, outstanding features of Visočica.

“At some points in both rivers, Bosna and Fojnica are paved areas with sandstone tiles which are visible with the naked eye”. If this feature is not found in any other surroundings, we may consider that it is unique to Plješevica Hrašće, Toprakalia and parts of the rivers.

The thickness of the beds or terraces is approximately 0.50 to 1.50 meters of *tafla* (marl or clay). They are a natural sedimentary *argillaceous rock*; lay down in fresh, brackish, or marine waters. The mineralogy is to some extent controlled by their environment of deposition.²⁰ They have accumulated on a rough plain which is not level, thus in beds, parallel to the irregular plain surface; following its ups and downs.



Photo from the Foundation

THE CLAY SEDIMENT OBEYS THE IRREGULARITIES OF THE PLAIN BELOW, BUT THE TILES LOOK AS IF THEY HAVE BEEN ARRANGED ARTIFICIALLY.

Above each bed is an amazing pavement of tiles of a thickness of a few to 20 centimetres and megalithic at Toprakalia.²¹ Dr. Ibrahim Jasarevic believes the tiles were manmade.²²

If the clay was brought by human labour, and that is farfetched, it may have been quarried out of some nearby, undiscovered tunnels of the substructure. If it was natural the tiled terraces would have been created over a few million years. Consequently the period of the construction of the terraces would be out of historical proportion. But there are a few outstanding observations recorded below; they are puzzling!

A loose parallel of the use of *tafla* (marl or clay) in Egypt is at Saqqara, at the Complex of Sekhemkhet, third dynasty (BC 2700). The unfinished step pyramid within that complex is buried in the *tafla*. It came from excavating the substructure and the subterranean galleries under this complex.

At Plješevica Hrašće the tiles excavated show that at the lower level terraces they are in a perfect state of preservation. At a little higher level the tiles appear to be a little worn out. It may possibly be that the preserved tiles were always buried until the Foundation exposed them and the worn-out ones were exposed in the past for cultural activities.

²⁰ *The Penguin Dictionary of Geology*, 1972.

²¹ The wonderful verity of the bed terraces, warrant a catalogue for this phenomenon alone. Suggestion # 4.

²² Reference # 7, *Documents ...etc of Visoko-Sarajevo, September 01, 2007*.



At SB 12, well preserved tiles



At SB 19, worn-out tiles

The logic of a clay terrace which is tiled, with similar terraces above, is a big question. In case of their exposure to human cultures the terraces with thin tiles would only endure walking; and we can assume that these terraces were exposed to make pathways for some reason. If heavy objects were dragged along them, these tiles would be crushed. I was told that there are no signs of crushed tiles.

Trimming the outer ends of the terraces can create the side to the pyramid. This kind of trimming would be easier than adding or removing stone as seen at Visočica. If the outer ends of the terraces are cut in a receding manner the ultimate shape would be achieved.

It is interesting how methods differ: the nuclei of early Egyptian pyramids were composed of accretion layers standing almost vertically upright and decreasing in height outwards (see figure above p. 10); while the nucleus of Plješevica Hrašće is composed of horizontal tiled clay terraces receding inwards (see below). Both arrangements create the pyramid shape but by different methods.



ON THE WEST SIDE OF THE PYRAMID HILL, TERRACES ARE RECEDING INWARDS. THE ANGLE OF THE PYRAMID SIDE CAN BE ESTIMATED AS 30°. ON THE PLATEAU THE TERRACES ARE RECEDING TO MAINTAIN A GENTLE SLOPE UPWARDS. IN BOTH CASES THE THICKNESS OF THE TOP SOIL IS CLEAR IN SECTION AND THE TILES ARE WELL PRESERVED BECAUSE THEY HAVE JUST BEEN EXPOSED

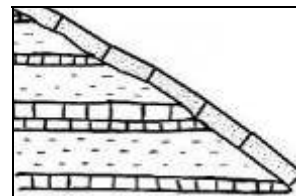
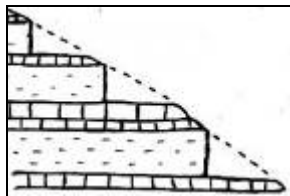

ROUGH SECTIONS DRAWINGS BY "IRNA" SHOWING A SERIES OF STEPPED AND INCLINED ENDS OF THE TILED CLAY TERRACES THE LATTER APPEARS TO BE CASED WITH SOME REGULAR MATERIAL

The excavation sites on the W side of Pljesevica Hrašće: Sonda 1, Sonda 7, Sonda 8, Sonda 12, Sonda 15 and Sonda 20, and on the Plateau: Sonda plato A, Sonda plato B and Sonda bu-

nar required careful work by the excavators. Disposing the debris rejected is a serious matter to consider because it would cover unexcavated areas which may need to be investigated in the future.

At Plješevica Hrašće the top soil had accumulated over parts of the pyramid nucleus and the vegetation grows. This means that the shaping of these parts of the pyramid nucleus had been achieved before the accumulation of the top soil. Dr. Husnija Resulovic has explained that the accumulation rate of one centimetre takes 250 - 300 years.²³ Since we have top soil thickness of at least 30 cm on areas of the sides and 100 cm on areas on the plateau, then we very roughly recon that the top soil on these areas was formed between 7500 to 30000 years. Consequently we may consider that these areas were naturally formed and that they were present before the evolution of man. In turn, the areas with thin layers of top soil are the most probable to have been shaped artificially. This result needs archaeological follow up before being generalised. The pyramid shape of Plješevica Hrašće especially the west side cannot be a result of nature alone. We have to consider that soil as a component of the outer facing.



W E

Photo from the Foundation

THREE (MAY BE 4) TERRACES PAVED WITH THIN TILES ARE CAREFULLY ARRANGED IN THE SAME DIRECTION BEARING 120°



N S

W

AT THE AREA SB1 OF PLJESEVICA HRASCE, AS IN ALL OTHER TERRACES, THE TILED SURFACE IS DECLINED INWARDS TO THE E AND TO THE LEFT N (BY 8°), SEE THE ACCUMULATION OF RAIN WATER. HOW FAR IN DO THE APPEARING TILED TERRACES GO?

²³ Reference # 2, Archaeological Park, Bosnian Pyramid of the Sun Foundation, online.



SB 8



SB 11



SB 19



SB 12



SB 15



SB15

THE PLATEAU

The plateau is the result of the pyramid hill being truncated. My visit to the site was short though there was much to investigate.

- In some sections of the digs the top soil is more than one meter thick.
- Below are layers of much more solid and hard clay.
- Neatly arranged tiles cover large areas which are unlevel.
- Multi layers or courses of stone are seen at the lowest levels of the excavations.

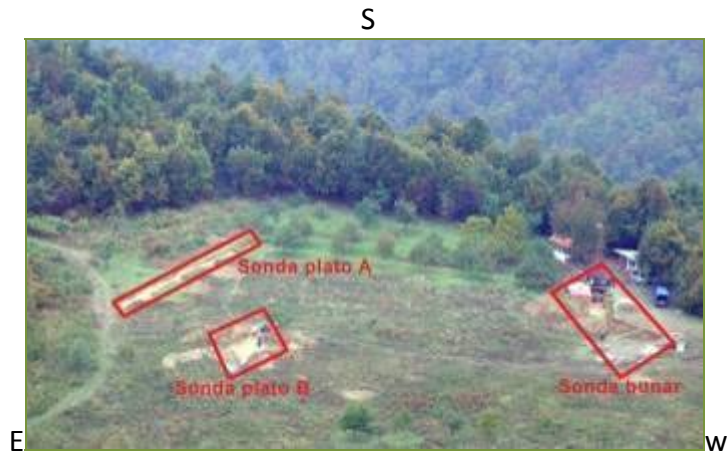

Photo from the Foundation



A HEAVY STONE STRUCTURE WITH AN INCLINED SURFACE. ABOVE IT ARE TWO TERRACES, SEEN IN SECTION.
A WELL SUNKEN FOR A FEW METERS SHOWS MULTI COURSES OR LAYERS OF STONE.



AT THE PLATEAU OF PLJESEVICA HRAŠĆE, WAXING AND WANING SLOPES OF A HARD CLAY TERRACE ARE NEATLY COVERED WITH TILES.

OUTSTANDING FEATURES AT PLJEŠEVICA HRAŠĆE



Photo by Klára Freidrich

CLOSE UP PHOTO OF THE BASKET WEAVE PATTERN



Photo from the Foundation

THE TILING IS ARRANGED IN STRIPS OF 5 METERS INCLINED TO THE NW. THE FOLLOWING STRIP BEGINS AFTER A DROP OF 5=7 CM.

At Sonda 1 the lowest tiles are thin conglomerate stone and the two terraces above small rectangular thin sand stone tiles. The terraces extend inwards to limits which may be impossible to follow. The clearance of the lower terrace has revealed that it was arranged in strips of 5 meters wide with a drop of 5 – 7 cm. Each strip is inclined 8° southwards and inwards. Semir has suggested that it is part of a spiral ramp, which is a good idea for calculating the ratio of distance to height.



AT THE PLATEAU STONE TILES ARE SET WITH ASTONISHING SKILL



AT SB1 DETAILS SHOWING THAT THE TILES WERE CAREFULLY SET TO FIT.



SANDSTONE PLATES ON W SIDE



ON THE PLATEAU TILES ARE LESS ELEGANT AND ARE OF CONGLOMERATE SANDSTONE.



AND SOME TILES ARE LIKE A COBBLE ROAD.



WELL PRESERVED TILES ON CLAY TERRACE



WORN-OUT TILES ON A ROCK TERRACE



ON THE PLATEAU CLEAR SECTION OF TOP SOIL AND THE HARD CLAY BELOW



LAYERS OR COURSES OF STONE

WHAT HAS BEEN INVESTIGATED SO FAR?

The report of July 2006 counts the advanced technological investigations dealing with the structure.²⁴ In each case there are positive reasons to conform the pyramid reality. Yet nothing has been revealed on dates and functions of the monument. The Subjects of the investigations are:

1. GEOMETRIC FEATURES OF THE PYRAMIDS
2. ORIENTATION - CARDINAL SIDES OF THE WORLD
3. APPARENT THERMAL INERTIA MEASUREMENTS
4. GEOLOGICAL-SEDIMENTARY ANALYSES
5. GEODETIC TOPOGRAPHIC COUNTOUR ANALYSIS
6. LINEAMENT DETECTION
7. FLUVIAL GEOMORPHOLOGY
8. RADAR ANALYSIS
9. EQUILATERAL TRIANGLE OF 3 MAIN PYRAMIDS
10. ARCHAEOLOGIC / GEOLOGIC EVIDENCE – FIELD CAMPAIGN 2006
11. TUNNEL EVIDENCE

²⁴ Reference # 3; *Bosnian Valley of Pyramids, Scientific Evidence about the Existence of Bosnian Pyramids*, July 2006.

ANALYSES

The following analyses deal with only two Bosnian Pyramid Hills. The actual number of the pyramid hills being identified in Bosnia is increasing. This is a short account.²⁵

- Visočica Summit height ASL 767 m.
- Plješevica Hrašće Summit height ASL 660.1 m.
- Bučki Gaj Summit height ASL 549.6 m.
- Vrela Summit height ASL 512 m.
- Četnica Summit height ASL 833 m.
- Krstac Summit height ASL 653 m.
- A pyramid hill reported by Aly Barakat?
- One which I actually saw, passing by at Zepce, (N of Zenica) .
- Mario Gerussi; told me about another at Maglaj (N of Zavidovici).
- A satellite image sent to me recently by Semir shows 9 pyramid hill possibilities to the S and W of Visočica.²⁶

Analyzing the pyramid hills Visočica and Plješevica Hrašće by the fundamentals of pyramid research we can see the following:

TERMS

Being a new branch of pyramid studies the Foundation is presenting the new term “*Bosnian pyramid hills*” to be used as a reference in pyramid research.

CONCEPTS

Our knowledge of their concepts is still in a stage of infancy. We know a little about their monumental concepts. Their historical and religious concepts, however, are still lagging behind.

PROPERTIES

The Bosnian pyramid hills possess some common properties with Egyptian and Mexican pyramids. Their local properties however as pyramid hills make them different.

Local properties

Central Bosnia is a beautiful country of mountains, rivers and forests. Nature has created the rock and clay formations of these mountains from marine and fresh water sediments in the Miocene geological era (25 million years ago) and their initial shapes were formed by the violent changes in the earth’s crust during the Pleistocene geological era (one million years ago). This had created the mountains and hills in the shapes we see everywhere. One regular feature appearing in those hills may be ignored. Nevertheless when regular features appear on two or three sides of one hill, with corners and sides oriented to the cardinal points, the case cannot be ignored. At Visoko we have three summits with those characteristics main-

²⁵ For all the new pyramid hills see Subjects Pending below.

²⁶ A satellite image and a view of Četnica are at the end in subjects pending.

taining a remarkable relationship to one another. ²⁷ Later tectonics and human intervention probably added the shapes we see today.

The local properties of the Bosnian pyramid hills at Visoko make them differ from other pyramids because:

- Their cores and parts of the nuclei are of geologically formed material.
- The faces of the nucleus of Visočica are shaped *naturally* by sloping beds of concrete like stone and breccias and by receding beds of the same formations.
- *Human intervention* removed thin layers of shale exposing a white and smooth hard face of the upper part of the nucleus.²⁸
- Gaps and depression were filled in and some geological analyses have shown artificial stone material.²⁹
- The faces of the nucleus of Plješevica Hrašće are shaped by receding terraces of tiled clay. The regularity of the sides could easily be achieved by trimming the outer edge of the soft clay terraces.
- The surrounding terrain is covered with a layer of top soil and green vegetation. This top soil on Visočica and Plješevica Hrašće may have been controlled to become their outer facing; i.e. man controlled agriculture; but this has not been proved.

Common properties

Looking carefully at Visočica and Plješevica Hrašće, in addition to the local properties we see that they possess various percentages of the common properties pyramids:

- i. Geometrical form.
- ii. Orientated setting.
- iii. Stabilized situation.
- iv. Mutual relationship.
- v. Connections with the plateau.
- vi. Forested all over.

GEOMETRICAL

As we already know in pyramid research the terms with added words, prefixes and suffixes, alters the classical meaning of the word pyramid. Many pyramids in Mexico, Peru and elsewhere do not possess all the 11 line property and are treated as pyramids in the literature. We have already mentioned that in some cases where a monument is founded on an unlevelled ground but maintains triangular sides and straight corner lines can be regarded as a pyramid.

To construct an ideal-free-standing-pyramid the sloping corner lines have to be of equal length and rise from the corners of the base. This situation is seen at most of the Egyptian pyramids. The corners are controlled as you build upward.

It is astonishing that with unequal corner lines, in length, the appearance of Visočica contains symmetrical triangles.

²⁷ At the heads of a 60° equal sided (2.2 KM) triangle.

²⁸ See footnote 15.

²⁹ *Documents ...etc of Visoko-Sarajevo, September 01, 2007.*

With the impossibility of leveling such vast areas at Visočica we can see that the corners rise correctly to meet at an apex above the plateau. Consequently the corners may have been calculated, somehow, downwards on a model of the terrain. This causes the corner lines to meet the ground at consequential points. These points will be at different levels and there will be no definite base or height. These facts geometrically make Visočica possess the common geometrical properties, though without the 11 line character.

ORIENTATION

The shaped sides at Visočica, Plješevica Hrašće, Bučki Gaj and the new pyramid hill Vrela are oriented to the cardinal points. The perfect orientation was measured by the Geodetic institute of Bosnia and Herzegovina. It is clear when reading the contour lines of the shaped sides on the map. Was this the result of astronomical knowledge or a coincidence?

STABILIZATION

The slopes adhering to angle of repose exist everywhere in the surrounding terrain, but in broken up segments. It exists from the top to the lowest points of the pyramid hills: Visočica, Plješevica Hrašće and the new pyramid hill Vrela in their flat sides. The resulting angle of this property gives the pyramid hills their esthetic appearance and stability.

RELATIONSHIPS

Their summits are at the corners of an equal sided (60° and 2.2 k m.) triangle measured by the Geodetic institute of Bosnia and Herzegovina with a tolerance of about 2%. Is this intended planning or a coincidence?

CONNECTIONS ³⁰

A pyramid hill joining the plateau may be explained as: An unfinished project, intended to be as such from the beginning, an early phase in the development of a free standing monument or for many other reasons.

The Kings of the 18-20 (BC. 1600- 1200) Egyptian dynasties selected the Valley of the Kings for their rock-cut-tunneled tombs, because of a natural pyramid formation overlooking this Valley (Wadi). The pyramid shape appears only from the Valley side; the opposite side joins the plateau. The truncated apex is the residence of a goddess called *Messergert*; the lady of silence.

³⁰ There are situations where an object joins some sort of background in their earliest phases of development: Many examples In Ancient Egyptian art especially statues; where a back pillar or a stone background is physically connected to each part of the statue. These are as if the statues are pulling themselves out for free independence. Thus, shall we look at the Bosnian situation as an early phase in the development of a free standing pyramid?



In that respect I would like to refer examples that are (partly) shaped and partly imbedded in some higher-topographical grounds. For example, pictured is Mount Rushmore National Memorial where statues are seen from one side only.



Photo copied from the internet

Two rock cut temples of King Ramses II and of Queen Nefertari at Abu Simbel are seen as temple facades with all characteristics from the E side only. They continue (from hypostyle hall to sanctuary) into the mountain. Looking from the back of these temples they are in harmony with the surrounding terrain.



FORESTED

Pyramids in rainy regions such as the rain forests at the Yucatan, Monte Alban, and others were originally or still are, covered by forests and vegetation. The Bosnian pyramids seem to suggest that their nuclei are either composed of beds of concrete like stone or horizontal clay terraces topped with neatly set tiles. These nuclei are evenly covered with a fertile top soil, where the vegetation grows.

THE PYRAMID AT PALENQUE, MEXICO, IS COVERED BY FORESTS AND VEGETATION.



CONCLUSIONS

Disagreements are the right of everyone and they have to be respected; but they have to show on what issues they disagree. Opinions or statements made without evidence are not decisive, rejections for no reason are not accepted, whims are not scientific, condescending and insulting statements must come to an end.

Otherwise reasonable disagreements on scientific matters have to be discussed and, if correct, accepted. In all cases we need to refrain from pseudoscientific, supernatural and romantic explanations.

The realization of the presence of the Bosnian pyramid hills have generated joy, anger and other reactions that range from reasonable to temperamental. The angry and temperamental who claim that there are no pyramids in Bosnia must know that in scientific research: *negative evidence is no evidence*.

The present shape of Visočica is seen from all directions as a pyramid, except SW corner. We see similar features with Plješevica Hrašće.

Terms

Up till this time Bosnia's pyramid research is still in its infancy yet much has been achieved so far: the terms have been assigned as *pyramid hills* and the names of the monuments have been labeled.

Concepts

As mentioned above, pyramid research investigates Monumental, Historical and Religious concepts. These issues are hidden in the physical edifice and in the unknown traditions.

The *Monumental* concept is slowly being understood. Geologists agree that the hills date to the Miocene geological era. The Pleistocene era and the following tectonics roughly shaped the hills. Human intervention brought them as much as possible to perfection. However, one must determine who was responsible for the intervention and over what time period it occurred.

Concerning the *Historical* and the *Religious* concepts, no background has bequeathed any impressions for us to cling to, except for some archaeological material and some petro glyphic signs which were found in the vicinity. They could be the key to some of these mysteries.

Properties

We realize that the pyramid hills have common and local properties. In regard to the common properties, they have some parallels with other pyramids in the world. Beyond these parallels a red line should be drawn because local properties in Bosnia have a different scenario.

INTERVENTION

If man shaped Visočica and Plješevica Hrašće then we have a project of adding and subtracting material to and from the natural hill. Some of these additions may be found in the out-

standing features and some of the subtractions in Aly Barakat's discussions mentioned above.

The preliminary results at Visočica consistently show that the nucleus was covered with beds of concrete like stone, while the nucleus at Plješevica Hrašće consistently show tiled clay terraces. In both cases the vegetation over the top soil may have been cultivated for the outer facing which gave the pyramid hill the ultimate appearance.

Parts of the NE corner unearthed at Visočica, show how it gracefully turns at right angles from the N side to the E side of the pyramid shape. More evidence should be available by further field work.

Concerning the *intervention of man* I believe that the results hitherto achieved have to be confirmed.

To improve the results of our investigation, we need to resolve some major issues:

- conform the geological data,
- conform human intervention,
- study historical material and
- decipher the petro glyphic signs.

THE FACADES

I have noticed that the shaped sides of the pyramid hills are facades beautifying the scenery along the south Valley of Visoko, while the opposite unshaped sides of the pyramid hills are looking at rough areas beyond. Was there something significant in that Valley? Is this observation worth noting? Does the Mound of Mother Earth, Krstac, in its focal position mean anything? At this point, I really do not know.

SUGGESTIONS

In addition to the Foundation's website and current archives, there is no doubt that an immense amount of data which is growing has to be updated and preserved. The expansion of the Foundation needs an elaboration of the existing.

- Log Book of events.
- Archiving reports, photographs, videos and related material.
- Cataloguing: records, finds and discoveries.
- Periodically publish an *Occasional Journal* as a professional arena for scientific debate.

REFERENCES

In my report I have learnt much from photographs prepared by Mario Gerussi, email correspondence with Nadir Cukurija, Merima Bojic, Aly Barakat and Semir Osmanagich. In my footnotes I have referred to the following references:³¹

- Semir Sam Osmanagich, *Bosnian Valley of the Pyramids*, Maunagic, 2006.
- Information on the website, <http://www.piramidasunca.ba>.
- A document on: *Bosnian Valley of Pyramids, Scientific Evidence about the Existence of Bosnian Pyramids*, July 2006.
- Aly Barakat, *Geological and Geo-archaeological Observations on the Bosnian Pyramids at Visoko Northwest Sarajevo*, July, 22, 2006
- *Multidisciplinary Project of Exploring the Bosnian Valley of Pyramids*, Sarajevo Maj. 2007.
- *Documents ...etc of Visoko-Sarajevo, September 01, 2007.*
- ³²على بركات: تقرير عن الأعمال الجيولوجية والجيوأركيولوجية التي تمت على أهرام البوسنة بمنطقة فيسكو خلال الفترة من 2006/5/16 - 2006/6/23 والفترة من 8/31 إلى 2007/9/11
- Nabil Swelim, *Some Problems on the History of the Third Dynasty*, Alex., 1983,
- Nabil Swelim, *The Brick Pyramid at Abu Rawash Number '1' by Lepsius a Preliminary Study*, Alex., 1987,
- Nabil Swelim, Pyramid Research from the Archaic to the Second Intermediate Period, Lists, Catalogues and Objectives, *Hommages à Jean Leclant*, Vol. 1 *Etudes Pharaonique Bibliotheque D'Etude* 106/1, Cairo, 1994,

³¹ I have been learning views of the distinguished: Mensur Omerbashich, Robert Schoch, Mark Rose, Anthony Harding, "Sejfudin Vrabac, Zilka Kujundzic-Vejzagic, Blagoje Govedarica and Colin Woodard. It was on line, by telephone, fax, email, and from published material by only a few of them.

³² This is a geoarchaeological report; it contains descriptions of the monuments at Visoko which are not covered in my report.

SUBJECTS PENDING:

THE PYRAMID HILL BUČKI GAJ



NEW PYRAMID HILLS ON THIS SATELLITE VIEW

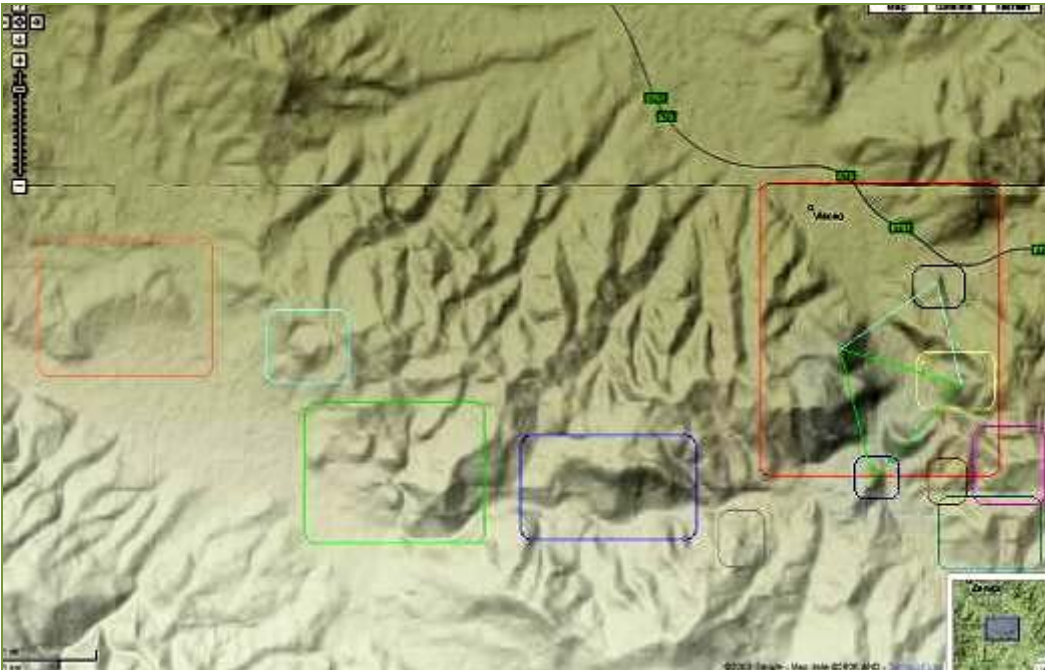

Photo from the Foundation

THE NEW PYRAMID HILL VRELA



THE MOUND TOPRAKALIA



IN AN AMAZING LOCATION IS THE KRSTAC HILL

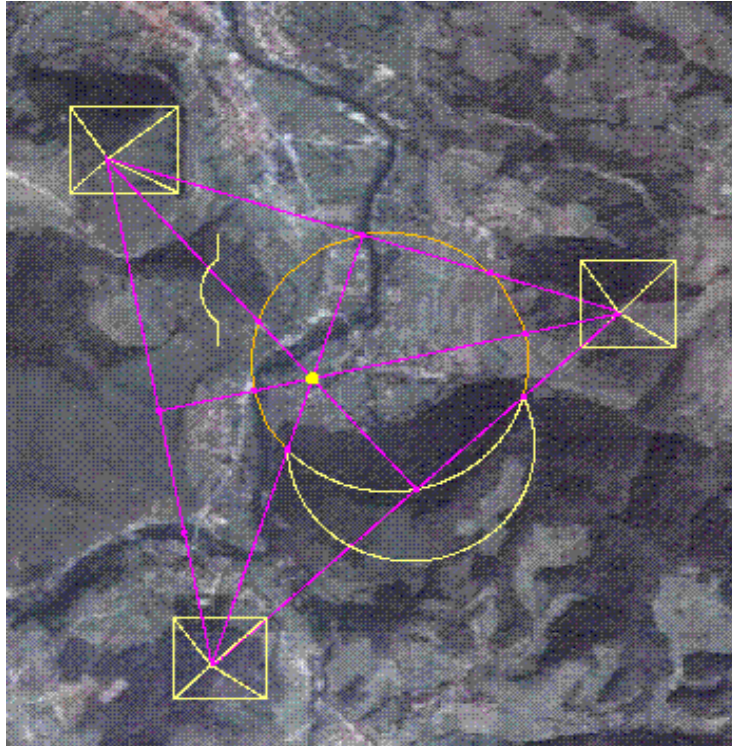

Photo from the Foundation

PYRAMID HILL CETNICA



Photo from the Foundation

TUNNEL KTK

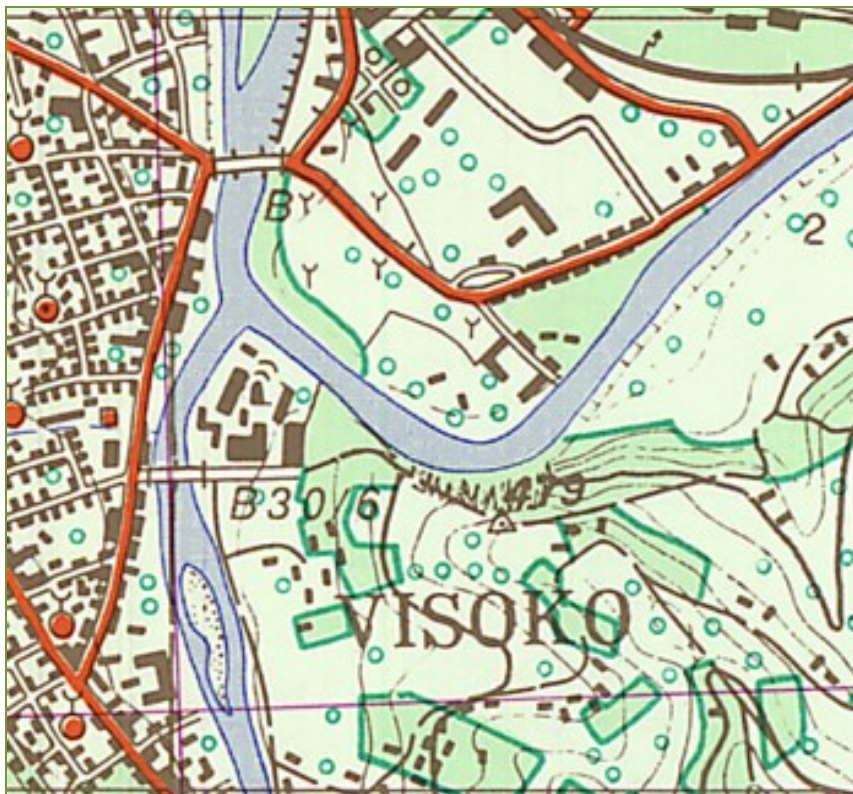

TUNNEL RAVNE



GRANITE SPHERE WITH ROUGH SURFACE; THERE ARE MANY OTHERS WITH POLISHED SURFACES



Photo from the Foundation

التلال الهرميه

VISOČICA و PLJEŠEVICA HRAŠĆE

ملاحظات و تحليل

30 اغسطس الى 12 سبتمبر 2007

نبيل سويلم

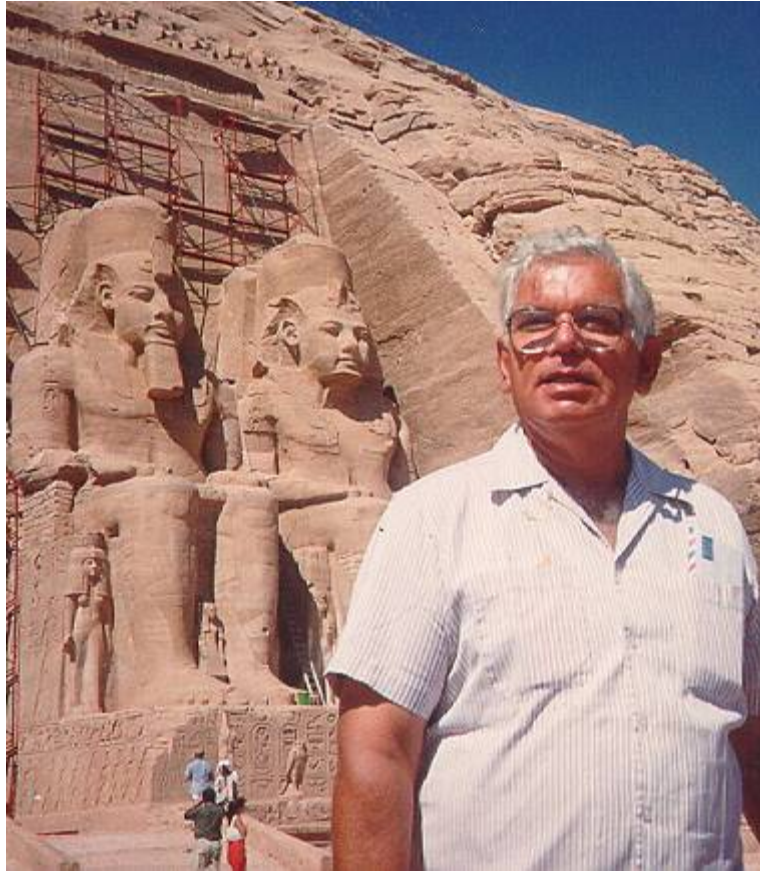

امام معبد رمسيس الثانى ابو سنبل